

## ELECTRICAL CONSIDERATIONS

### NOTE

Make sure all electrical installation is in accordance with national and local code requirements.

## Power Supply

The DC power supply should provide power with less than 2% ripple. The total load is the sum of the resistance of the signal leads and the load resistance of the controller, indicator, and related pieces. The resistance of intrinsic safety barriers, if used, must be included. Figure 2-7 illustrates power supply load limitations for the transmitter.

Figure 2-7. Power Supply Load Limitations.

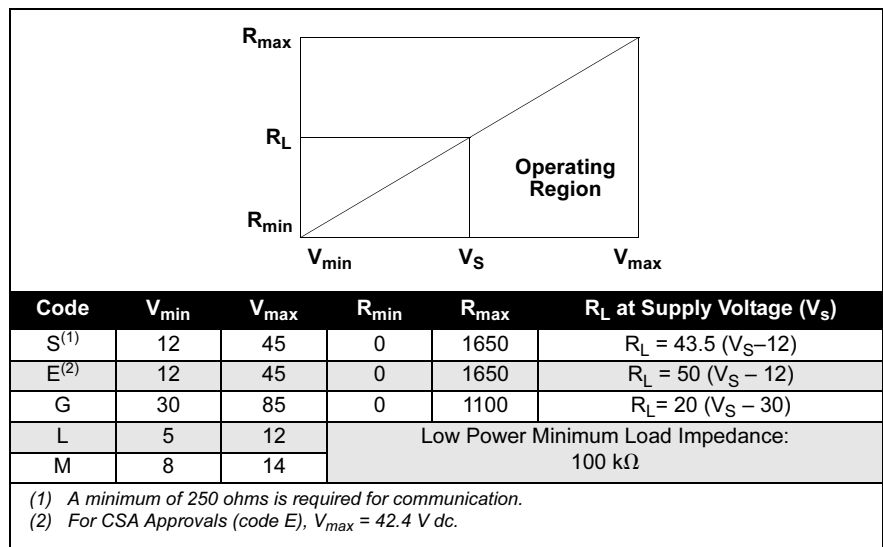

## Conduit Installation

**⚠ CAUTION**

If all connections are not sealed, excess moisture accumulation can damage the transmitter. Make sure to mount the transmitter with the electrical housing positioned downward for drainage. To avoid moisture accumulation in the housing, install wiring with a drip loop, and ensure the bottom of the drip loop is mounted lower than the conduit connections or the transmitter housing.

Recommended conduit connections are shown in Figure 2-8.

Figure 2-8. Conduit Installation Diagrams.

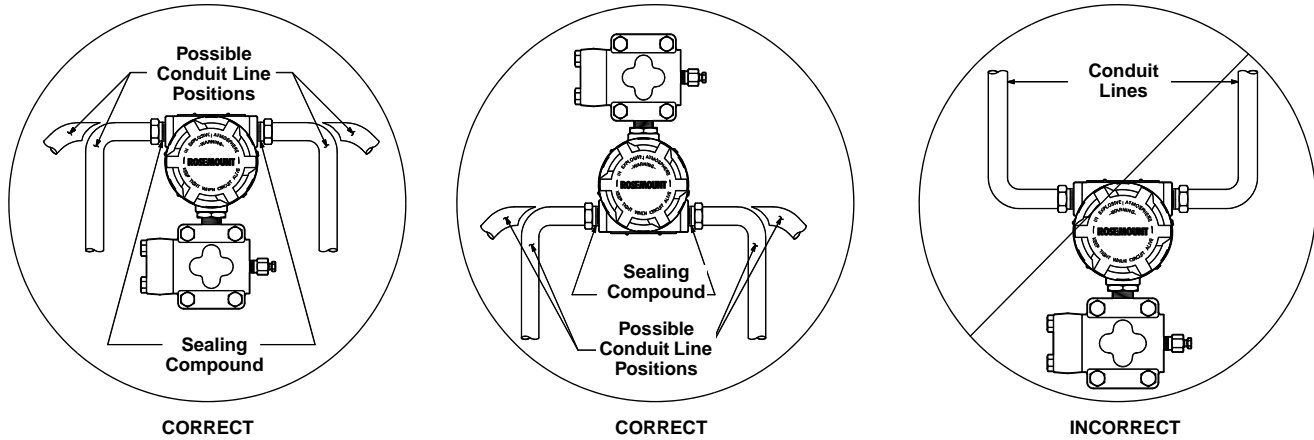

## Wiring

### ⚠ CAUTION

Do not connect the power signal wiring to the test terminals. Voltage may burn out the reverse-polarity protection diode in the test connection. If the test diode is destroyed, then the transmitter can still be operated without local indication by jumping the test terminals.

High voltage (greater than 50 V and greater than 0.005 amperes) can cause damage to the transmitter. Do not apply high voltage to the test terminals.

The signal terminals and test terminals are located in a compartment of the electronics housing that is separate from the transmitter electronics. The nameplate on the side of the transmitter indicates the locations of both of these compartments. The upper pair of terminals are the signal terminals and the lower pair are the test terminals. The test terminals have the same 4–20 mA output as the signal terminals and are only for use with the optional integral meter or for testing.

### NOTE

An alternate location to connect an ammeter is on the set of terminals labeled “TEST.” Connect the positive lead of the ammeter to the positive test terminal, and the negative lead of the ammeter to the negative test terminal.

⚠ To make connections, remove the cover on the side marked “Terminal” on the nameplate. All power to the transmitter is supplied over the signal wiring. Connect the lead that originates at the positive side of the power supply to the terminal marked “+” and the lead that originates at the negative side of the power supply to the terminal marked “-”. No additional wiring is required.

Do not run signal wiring in conduit or open trays with power wiring or near heavy electrical equipment.

For improved performance against EMI/RFI effects, refer to “Terminal Blocks” on page 2-24 for information on transient protection terminal blocks.

Shielded cable should be used for best results in electrically noisy environments. Refer to “Grounding” on page 2-16 for more details.

---

**NOTE**

When conduit lines are used, signal wiring need not be shielded, but twisted pairs should be used for best results. Wiring must be 24 AWG or larger and not exceed 5,000 feet (1500 meters).

---

---

**NOTE**

A minimum loop resistance of 250  $\Omega$  is required to communicate with a hand-held HART-based communicator. With 250  $\Omega$  of loop resistance, the transmitter requires a minimum of 17 volts to output 20 mA. If a single power supply is used to power more than one Rosemount 1151 Smart transmitter, the power supply used, and circuitry common to the transmitters should not have more than 20  $\Omega$  of impedance at 1200 Hz.

---

## Grounding

⚠ Use the following techniques to properly ground the transmitter signal wiring and case:

### Signal Wiring

Do not run signal wiring in conduit or open trays with power wiring or near heavy electrical equipment. It is important that the instrument cable shield be:

- Trimmed close and insulated from touching the transmitter housing
- Connected to the next shield if cable is routed through a junction box
- Connected to a good earth ground at the power supply end

Signal wiring may be grounded at any one point on the signal loop or may be left ungrounded. The negative terminal of the power supply is a recommended grounding point.

### Transmitter Case

The transmitter case must be grounded in accordance with national and local electrical codes. The most effective transmitter case grounding method is a direct internal connection to earth ground with minimal impedance. The transmitter case may also be grounded through the process or conduit connections.

**Internal Ground Connection:** Inside the field terminals side of the electronics housing is the internal ground connection screw. This screw is identified by a ground symbol: .

---

**NOTE**

Grounding the transmitter case via threaded conduit connection may not provide sufficient ground continuity.

---

---

**NOTE**

The transient protection terminal block (page 2-25) does not provide transient protection unless the transmitter case is properly grounded. Use the preceding guidelines to ground the transmitter case.

Do not run the transient protection ground wire with signal wiring as the ground wire may carry excessive current if a lightning strike occurs.

---

**Grounding Effects**

The capacitance sensing module requires alternating current to generate a capacitance signal. This alternating current is developed in an oscillator circuit with a frequency of approximately 32 kHz. This signal is capacitor-coupled to transmitter-case ground through the sensing module. Because of this coupling, a voltage may be imposed across the load, depending on the choice of grounding. See Figure 2-9.

Impressed voltage, which is seen as high frequency noise, will have no effect on most instruments. Computers with short sampling times in circuits will detect a significant noise signal, which should be filtered out by using a large capacitor (1 μF) or by using a 32 kHz LC filter across the load. Computers that are wired and grounded, as shown in Figure 2-9, are negligibly affected by this noise and do not need filtering.

Figure 2-9. Effects of Grounding on Accuracy for Fast Sample Computers.

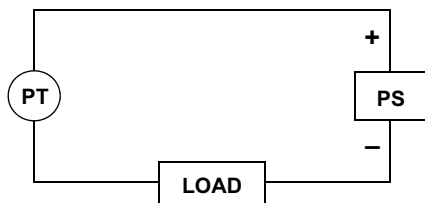

**Ungrounded System**

Impressed Voltage: 12 to 22 mV<sub>p-p</sub>  
 32 kHz

Effect: 0.01% of span, max.

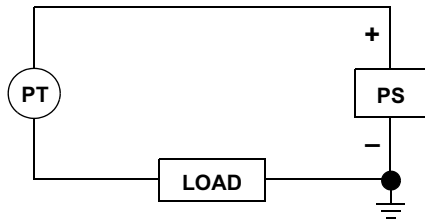

**Ground Between Negative Side of Power Supply and Load**

Impressed Voltage: 35 to 60 mV<sub>p-p</sub>  
 32 kHz

Effect: 0.03% of span, max.

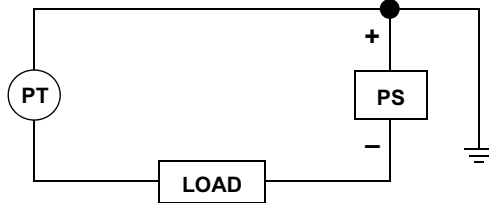

**Ground Between Positive Side of Transmitter and Power Supply**

Impressed Voltage: 35 to 60 mV<sub>p-p</sub>  
 32 kHz

Effect: 0.03% of span, max.

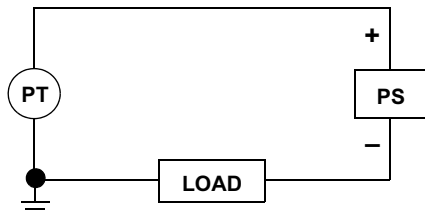

**Ground Between Negative Terminal of Transmitter and Load**

Impressed Voltage: 500 to 600 mV<sub>p-p</sub>  
 32 kHz

Effect: 0.27% of span, max.

\*The effect caused by the impressed voltage on a computer with a sampling time of 100 microseconds using a 2 to 10 volt signal.